



## **USER'S MANUAL**

**2008**

TOPEX is a group of Romanian companies, founded in 1990, by 10 enthusiastic engineers experienced in telecommunications. Its activity is directed to the research, development and production of telecom equipment as well as service for them.

TOPEX becomes very quick the most important supplier of IT&C solutions for small to large companies as well as for telecommunications operators and providers in Romania. The company designs equipment for all existing mobile systems (GSM/GPRS, CDMA/EVDO, HSDPA), including 3G technologies.

TOPEX is represented all over Romania by a wide network of local distributors through which the promotion, administration and product maintenance are running.

Due to our innovation power, authentic flexibility, real respect for our partners and secure solutions that we provide TOPEX extended its business worldwide. Currently TOPEX delivers its products through its distributors to: Italy, France, Spain, Bulgaria, Greece, Niger, Russia, UK, Republic of Moldova, Turkey, Holland, etc.

In order to achieve effective and flawless manufacturing for its products, TOPEX has carefully organized its Research and Development Department along with its production facility. This allows TOPEX to have maximum control of all the processes involved in the complex operations related to high-technology electronic manufacturing. At the present time, the Research and Development Department counts 30 specialists and the trend is ascending.

TOPEX also considered the training and the service as part of the solutions it provides. Therefore, comprehensive trainings are organized at Topex Factory, complimentary for the company's clients. Service is also provided via Internet, as all Topex solutions are designed especially to allow this, at the lowest cost.

TOPEX has implemented the quality management system according ISO9001 standard certified by SRAC since 1997, respectively by IQNET since 2002. TOPEX become a sector member of I.T.U. (International Telecommunication Union) since 2001.

The main lines of products of our company are:

- GSM/GPRS/UMTS/HDSPA/CDMA interfaces (analog, ISDN BRI and PRI, GSM gateway, broadband wireless routers)
- SIM Servers;
- VoIP gateways ;
- Signaling converters and Protocol Translators (SS7, SIP, H323);
- ATC Voice Communication Systems (custom systems for special applications: air traffic control, railway dispatching center)
- Softswitches and media gateways.

For more details please visit [www.topex.ro](http://www.topex.ro)

## CONGRATULATIONS!

Dear client,

Thank you for buying MobiLink ISDN 2 GSM and congratulations for your excellent choice!

By purchasing MobiLink ISDN 2 GSM you have opted for:

- ✓ cutting down the costs of your cellular calls
- ✓ mobile-2-ISDN interface with LCR capabilities
- ✓ excellent quality of audio signal
- ✓ availability of SMS and data functions
- ✓ convenient, easy to use e-mail to SMS and SMS to e-mail feature
- ✓ perfect compatibility to ISDN private branch exchanges (PBX)
- ✓ routing functions assured even when used as standalone unit
- ✓ full compatibility with GSM 900/1800 or 850/1900 networks
- ✓ saving of ports in your PBX exchange
- ✓ easy and quick installation and usage
- ✓ small investment, it pays itself off in the first month, then you achieve important savings of phone bills

**WEEE Directive Compliance****WEEE Directive**

This symbol applied on your product or on its packaging means that this product fulfils the WEEE Directive. The product shall not be recycled as household waste; it will be disposed separately as sorted waste.

Regarding to WEEE Directive the recycling EE equipments must be accomplish separately in purpose of natural resources preserving and to avoid the occurring negative effects about human health and environment. The acquired product shall not be treated like household waste at the end of its life and will be returned to TOPEX Company at the address: ROMANIA, Bucharest, Feleacu Street no 10, code 014186 or given to a specialized firm.

! Please do not dispose your TOPEX product as unsorted waste (household waste), recycle it to protect the environment. Separate the packages according to waste disposal options and sort it for recycling.

For supplementary information contact us to:  
**Phone: +4021 408.39.00 or [www.topex.ro](http://www.topex.ro)**

**Several problems:**

- Any call from a fixed phone to a mobile network includes two kinds of charges: the fee of the wireless carrier (operator) and the fee for the fixed telephony operator
- Additionally, the calls to your headquarters from the mobile phones of your employees at remote locations are also charged twice
- You have to pay several mobile subscriptions with high tariff per call
- If you use a vocal mailbox, you must pay for checking your messages
- When you have a ISDN exchange, the ISDN features and services are not directly connected to the GSM network
- GSM phone bill may be difficult to control; you may end up paying large costs for the calls performed.

**One solution:**

MobiLink ISDN 2 GSM achieves a direct link between the ISDN phone exchange in your office and the wireless phone network. Consequently, it is easier to connect and the costs of fixed-to-mobile calls will be cut down by as much as 60%. You will avoid telephone fees for the interconnection between GSM network and the PSTN carrier. Also, calls coming from the cell phones of your personnel out in the field will be cheaper as well.

Since all mobile calls are now brought together, you may use the most convenient tariff rate of your GSM operator (low cost per call for high volume of traffic).

When you connect your own voice mailbox to the ISDN 2 GSM interface you no longer have to pay for listening to voice messages or for reading the messages.

The MobiLink interface allows you to restrict outgoing calls to certain phone numbers, so you won't have to pay anymore for the calls that you restricted.

By means of the MobiLink ISDN 2 GSM unit, you can use the ISDN services together with the GSM services, it enables several kinds of ISDN connection. You have a simple means to use conditioned and unconditioned call forwarding. You easily can send and receive SMS messages from your computer.

The device can also provide detailed records of time and duration of outgoing calls, so you keep your phone costs under control.

## TABLE OF CONTENTS

TABLE OF CONTENTS.....	7
TABLE OF FIGURES.....	8
1. What is MobiLink ISDN 2 GSM? .....	9
2. Package content.....	10
3. Installation .....	12
3.1. Identifying the connectors .....	12
3.2. Configuring the SIM cards .....	13
3.3. Inserting the SIM cards .....	14
3.4. Connecting the cables .....	16
3.5. Installing the external antennas .....	18
3.6. Jumper settings .....	20
3.7. Bootloader enable.....	20
3.8. Terminal resistors .....	21
3.9. Power up MobiLink ISDN 2 GSM.....	22
3.10. Significance of LED indicators .....	23
3.11. Pinout for the connectors.....	24
3.12. Mounting the MobiLink ISDN 2 GSM equipment .....	27
4. Installing the OAM program.....	29
5. Operation and modes of connection.....	30
5.1. Routing for least costs .....	30
5.2. Four modes of connection .....	31
5.2.1 MobiLink connected via NT to a TE junction of the PABX .....	31
5.2.2 MobiLink connected via TE to NT local of PABX and via NT to TE junction of the PABX.....	32
5.2.3 MobiLink connected to PBX on NT interface and to public ISDN via TE interface .....	33
5.2.4 MobiLink connected to PABX via TE only .....	34
5.2.5 Using several MobiLink ISDN 2 GSM units.....	35
6. Technical specifications .....	37
7. Operating environment.....	38
8. Benefits .....	40

## TABLE OF FIGURES

Figure 3-1 Identifying the connectors.....	12
Figure 3-2 Location of SIM slots .....	14
Figure 3-3 Connecting the cables .....	16
Figure 3-4 Connecting external antennas .....	18
Figure 3-5 Location of jumpers. ....	20
Figure 3-6 JP5 jumper location .....	21
Figure 3-7 Location of JAT1, JAT2, JAN1 and JAN2 jumpers .....	21
Figure 3-8 Location of the LED status indicators .....	23
Figure 3-9 Serial connector.....	24
Figure 3-10 Usage of SY connector.....	27
Figure 3-11 Mounting MobiLink on a wall .....	28
Figure 4-1 Configuring MobiLink via serial connection.....	29
Figure 5-1 MobiLink connected to TE junction of PBX.....	31
Figure 5-2 MobiLink connected to PBX with both NT and TE interfaces.....	32
Figure 5-3 MobiLink inserted between PBX and public network ...	33
Figure 5-4 MobiLink connected to NT local of PBX .....	34
Figure 5-5 Cascading several MobiLink units .....	35
Figure 5-6 Location of JAT1, JAT2, JAN1 and JAN2 jumpers .....	36

This manual is Revision F, June 2008 and contains 39 pages.



## 1. What is MobiLink ISDN 2 GSM?

It is an advanced interface for your profit!

By interfacing between an ISDN phone exchange and the mobile telephony network (GSM 900/1800 or 850/1900) it cuts down the costs of fixed-to-GSM and GSM-to-fixed calls. ISDN 2 GSM was designed to be connected to any ISDN phone exchange so it meets standard ISDN PBX requirements.

It may be used as GSM interface for an ISDN a phone exchange. Even when used as standalone unit with an ISDN phone set it can still perform routing of the calls for minimum costs. Also, by means of a terminal adapter it can be used with analog (standard) telephones or with a payphone.

The unit works primary in voice mode, that is re-routes incoming or outgoing calls through the corresponding wireless network. This way you will pay just the cost of a mobile-to-mobile call inside the same carrier network, instead of the cost of fixed-to-mobile call.

The interface enables several types kinds of ISDN connection and may be used for services such as call forwarding (conditioned or unconditioned), DISA and voice messages.

When connected to a computer, you may use the MobiLink ISDN 2 GSM equipment to receive and send out SMS.

By connecting MobiLink ISDN 2 GSM to an ISDN phone exchange, all local extensions can make calls to GSM networks while keeping down the costs. Also, when making a call the subscriber is no longer subjected to RF radiations from the cell-phone. Also, the external antennas can be located in a place for optimal reception (higher intensity of the radio signal).

Since MobiLink ISDN 2 GSM can send billing pulses, you may also use a public telephone (payphone) with it, by means of terminal adapter.



Finally, ISDN 2 GSM may be used as small ISDN phone exchange by itself, since it can interconnect up to 8 ISDN local phones and perform automated routing of calls for minimum cost.

The unit includes the GSM modules, so it does not need supplementary devices (such as a external GSM phones) to work. Its two SIM cards allow routing the call through the corresponding GSM operator, for least cost.

Its installation is simple; you just insert the SIM cards and plug in the cables (serial configuration, ISDN lines, external antennas, power adapter). This comes very useful for the SOHO (small office/ home office) market.

## 2. Package content

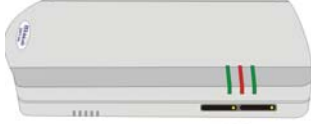
When you unpack the MobiLink ISDN 2 GSM unit from its protective cardboard box you should identify the components described in the table below. Please ensure that you received the suitable contents; also check that all components are accounted for and that no damage has been sustained during the transport.

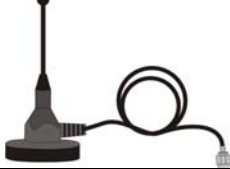
Item	Image	Pcs/ Note
MobiLink ISDN 2 GSM equipment		1
Serial programming cable for MobiLink ISDN 2 GSM		1/*
Power supply adapter 12VDC / 2,08A		1
External antennas		1-2/ **
Wall mounting kit	-	1 /***
CD with OAM software	-	1/ ****
User's manual	-	
Warranty certificate	-	

**Notes:**

*\*) The package also contains two connecting cable for TE and NT interfaces*

*\*\*\*) Depending on what MobiLink ISDN 2 GSM model of equipment it is (with one or two GSM modules) you will have one or respectively two antennas.*

*\*\*\*) The kit for mounting MobiLink on a wall includes dowels, woodscrews, etc.*

*\*\*\*\*) OAM software supplied with MobiLink (isdncfg) includes functions for configuring (programming) the ISDN to GSM interface, routing of calls, sending and receiving SMS. It also includes online help with examples*

### 3. Installation

#### 3.1. Identifying the connectors

The bottom of the case of MobiLink ISDN 2 GSM unit features all the supply/voice/data connectors:

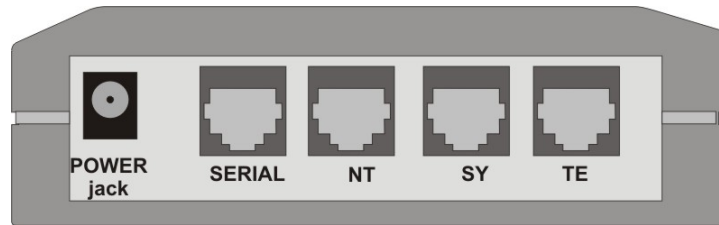

**Figure 3-1 Identifying the connectors**

- **PWR** – female connector, jack type, for the power supply adapter
- **SERIAL** – female RJ-11 connector with special pin-out, for the serial cable used for configuration (for the connection to PC is used a DB9 muffle)
- **NT** – Network Termination for 4-wire ISDN phone line. Connects MobiLink ISDN 2 GSM to the TE of the ISDN PBX or the ISDN phone set (analog phone may be used via terminal adapter)
- **SY** – synchronization, connections paralleled with TE slot. Used for clock signal synchronization, when cascading several ISDN 2 GSM units together
- **TE** – Terminal Equipment connector for ISDN is used for connecting to an ISDN phone exchange or to the ISDN public telephony network and also, for connecting more than one MobiLink ISDN 2 GSM unit to the same PBX.
- The two **FME** connectors for the external antennas are located on top of the MobiLink ISDN 2 GSM equipment, while the slots for the SIM cards and their pushbuttons can be found on the right side of the case, under the LED indicators.

### 3.2. Configuring the SIM cards

The SIM cards that will be used with MobiLink ISDN 2 GSM must be **activated** by the corresponding GSM operator. Also, they must be properly **configured** before insertion in the GSM slot of the equipment. The configuration of the SIM cards is performed using a GSM phone.

- **Disable request for PIN code** – If the “PIN Code Request” option is disabled, you can insert any value in the “Pin Code” field of the OAM program. When you enter the correct PIN code, it will be stored in the equipment memory and afterwards you need no more bother about PIN code. The MobiLink unit must be connected with the computer that runs the OAM program thru a serial connection in order to modify the “PIN Code” (for more details check the “User manual” for the isdnrcfg program).
- **Disable GSM services** – most GSM operators assure several services (redirection of calls, vocal mailbox) concerning treatment of incoming calls. These are very useful in case you cell-phone is busy or disconnected; it is advantageous to use the call forwarding features provided by the GSM carrier. But when you use the MobiLink ISDN 2 GSM interface together a phone exchange it is generally better to disable those services, because you perform them locally with smaller costs.
- **Disable Auto-redialing and Auto-answer** – you must disable these options, if they are provided by your GSM operator.
- **Turn off roaming** - international roaming services allows you to make calls with the same GSM subscription when you travel in other countries (where the service provider has signed a signed roaming contract with your GSM operator). The roaming option should be disabled, because MobiLink was designed to work with PBX or ISDN phones in stationary applications. You won't take it in overseas trips! If roaming remains enabled, it is possible that when the local GSM carrier is interrupted, the ISDN 2 GSM interface will connect to a foreign mobile operator and the costs of the calls will be much higher.

**Settings for configuration of the SIM cards**

Description	Option
Select "OFF" for "Dial again – Interval".	If this option exists
Select "OFF" for "Auto Answering"	required
Select "OFF" for "Call Waiting"	required

**3.3. Inserting the SIM cards**

The ISDN 2 GSM interface needs SIM cards for the corresponding GSM operators.

Each SIM card must be inserted in the corresponding slot of the MobiLink ISDN 2 GSM unit. Depending upon the equipment model, it may feature one or two GSM modules, hence one or two slots for SIM cards.

The slots for SIM cards are located on the upper right side of the MobiLink case, under the LED indicators. To insert/ remove the SIM, use the removable tray (SIM holder) which is activated by a small yellow pushbutton.

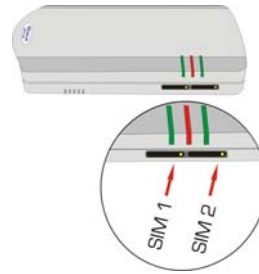

**Figure 3-2 Location of SIM slots**

**Note:**

*To push the ejector button, because of its small size, you may need to use a tool with a small, hard tip (keys, pen, screwdriver or tweezers). Handle the SIM cards with care!*

**WARNING!**

Unplug the MobiLink unit from the main outlet before insert or replace a SIM card!

For each of the SIM card, follow these steps:

1. Press the little button to eject the SIM holder.

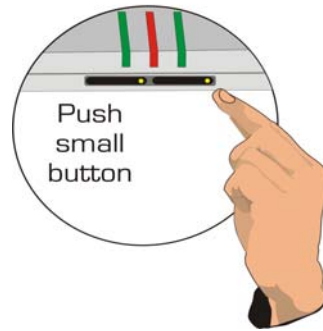
**STEP 1**

2. Pull out (extract) the tray (SIM holder)

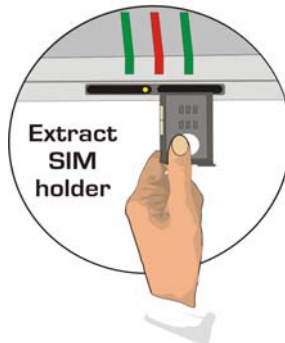
**STEP 2**

3. Insert SIM card into the holder, as shown – with cut corner upwards and with contacts facing you

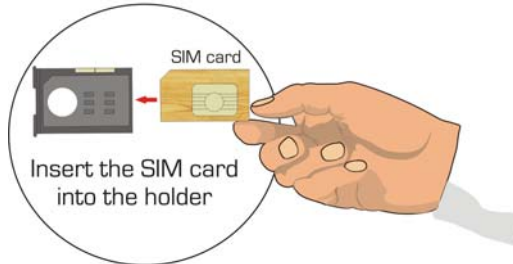
**STEP 3**

4. Push the holder tray with the SIM inside back into the corresponding slot of the MobiLink unit

#### STEP 4

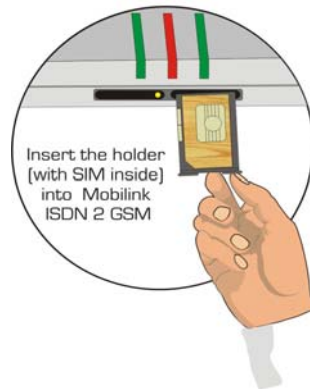

You should follow the steps described above also when you need to replace the SIM cards already installed into MobiLink.

### 3.4. Connecting the cables

Connect the data, phone and power cables as shown in the drawing below:

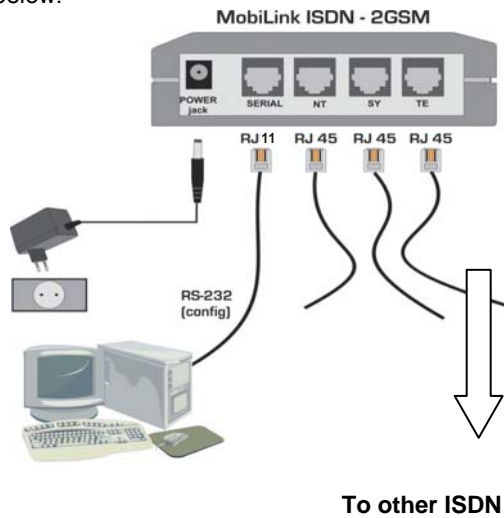

Figure 3-3 Connecting the cables



Use ISDN cables to connect the Topex unit to your ISDN PBX (or other ISDN terminals). Connect the cables from your corresponding ISDN device to the MobiLink unit. More detailed information on correct connections can be found in chapter 4.2. "Modes of connection".

**For each MobiLink ISDN interface**, insert one end of the 4-wire ISDN phone cable in the TE or NT connector of the MobiLink ISDN 2 GSM. The opposite other end of the cable must be connected to the corresponding local or junction interface of the ISDN PBX or to the ISDN phone. The pinout of RJ-45 connectors for TE and NT interfaces is shown in tables at Chapter 3.9 "Pinout for connectors". You should always select the individual NT, TE or SY connections in accordance with chapter 4.2. „Modes of connection“. In order to achieve a good operation, you have to know the pattern of connections required for the application (links required by the ISDN phone exchange or telephone terminals).

**Serial programming connection** – To be able to adjust configuration of your ISDN 2 GSM interface using of the OAM program, you must connect your equipment to a PC. The connection is performed by means of a special cable that connects to the „SERIAL“ slot of the MobiLink device. The serial connection is also necessary for sending and receiving SMS messages from your PC.

Insert the jack of the power supply adapter (shipped in the MobiLink package) into the PWR connector. Do not yet plug the adapter into the receptacle of the 230V ac mains outlet!



**Note:**

*If you start up MobiLink ISDN 2 GSM and the antennas are not connected, the transmitter of the GSM module could be damaged.*

### 3.5. Installing the external antennas

MobiLink ISDN 2 GSM features two RF connectors on top, for connecting the antennas for the wireless network. You may use:

- the wideband antenna supplied with the package, with cable and magnetic base (see below characteristics)
- or other kinds of external antennas with higher gain or directivity (Yagi), if the need arises.

The following table shows the main characteristics of the dual-band stick antennas with magnetic base (currently supplied with the MobiLink ISDN 2 GSM package).

Frequency bands	GSM 890-960 MHz PCN 1710-1880 MHz PCS 1850-1990 MHz
Gain	2 dBi
Polarization	Vertical
Base	Magnetic, 2,8cm
Cable	Type RG174, length 2,5 m
Connector	Female FME

The two antennas must be threaded to the FME male connectors located on top of the MobiLink ISDN 2 GSM unit, as shown in the following drawing.



**Figure 3-4 Connecting external antennas.**

Plug the cable connector and tighten the flange lightly, by hand. Do NOT use a spanner or screw key, which could damage the antenna connectors!

The external antennas must be installed in a place with a good strength of the GSM signal. The antenna has vertical polarization; it must be placed in vertical or horizontal position, depending of the local field condition.

If the SIM cards used are for different GSM operators, you may need to place each antenna in a location with maximum strength of the received signal from the respective GSM carrier.

MobiLink ISDN 2 GSM and its antennas must be located as far as possible from equipment that is sensitive to electromagnetic interferences (radios, audio or video appliances, computer monitor, TV receivers etc). If you place the MobiLink interface or its antennas too near radio, TV, or other sensitive appliances, their operation could be affected.

**Note1:**

*The antennas of the MobiLink ISDN 2 GSM interface sends out RF energy so they should NOT be placed very close to people. Since the GSM interface transmits for longer periods of time, being used by several people (most of the calls of local subscribers are routed through it) the radiation will be accordingly **higher** than for a cell-phone used only infrequently, by a single person.*

**Note2:**

*Remember to connect the antennas before powering up MobiLink, to avoid damage to the transmitters of the GSM modules*

### 3.6. Jumper settings

MobiLink ISDN 2 GSM features several jumpers located on the printed circuit board, inside the plastic case of the equipment. These jumpers control functions seldom accesses, so that in normal operation you do not need to change the settings.

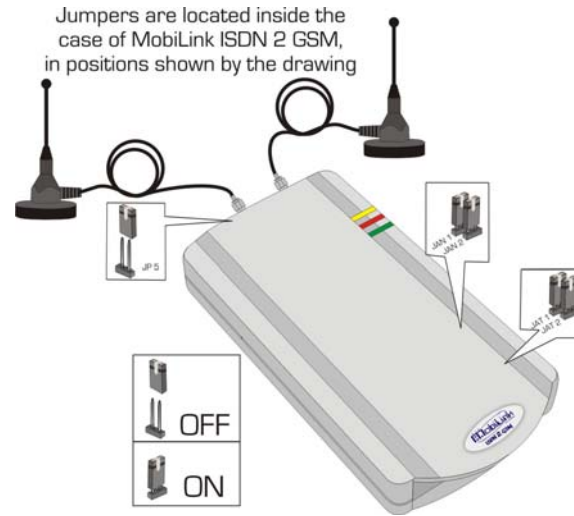

Figure 3-5 Location of jumpers.

### 3.7. Bootloader enable

#### Use

If an abnormal interruption occurred in the loading of an image file, you must use the JP5 jumper.

To fix this problem, you must set the jumper on the JP5 pins to force the bootloader to start. In order to load a new image file please refer to the isdncfg OAM manual.



**Note:**

*Remember to take the jumper off pins JP5 before resuming normal operation of the ISDN 2 GSM equipment.*

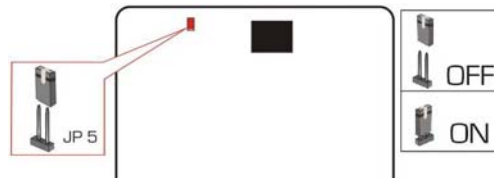
**Location****Figure 3-6 JP5 jumper location**

Jumper JP5 is located near the top left corner of the printed circuit board of MobiLink. Immediately to the right of JP5 you can see the connector for the external antenna. JP5 is alone (no other jumpers in the near) and it is in vertical position.

**3.8. Terminal resistors****Use**

These pairs of jumpers (JAN1 and JAN2 for the NT interface, JAT1 and JAT2 for the TE interface) configure the impedance matching (termination) resistors for the respective interfaces.

By default, these jumpers are ON so the terminal resistors are connected. You should take the jumpers OFF if terminal resistors are not required.

When you have several ISDN devices connected to an ISDN line, the line must end with impedance matching resistors, also called terminal resistors. This is required, for instance, when cascading several MobiLink interfaces and using synchronization.

One solution for termination is to use a terminal block with matching resistors inside. But if the last device is a MobiLink equipment, you can use the termination resistors that are included with the equipment. Remember, out of several MobiLink units cascaded on the ISDN line, only the last unit must have the termination resistors enabled.

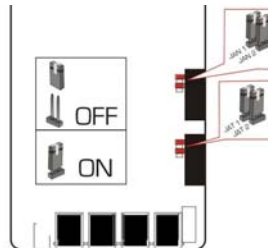
**Location****Figure 3-7 Location of JAT1, JAT2, JAN1 and JAN2 jumpers**

The pairs of jumpers (JAN1 and JAN2 for the NT interface, JAT1 and JAT2 for the TE interface) are located towards the right edge of the MobiLink printed circuit board, at middle-bottom. Each pair of jumpers is near a black rectangle (ISDN transformers). JAN1 and JAN2 are the first pair; below them you may find the second pair, JAT1 and JAT2 respectively. The jumpers are in horizontal position.

### 3.9. Power up MobiLink ISDN 2 GSM

Insert the jack of the power supply adapter (shipped in the MobiLink package) into the PWR connector.

Then plug the adapter into the receptacle of the 230V AC mains outlet. MobiLink ISDN 2 GSM will start working immediately. You should see the green LED indicator (PWR) lighting up.

#### **WARNING!**



To avoid accidents or damage to the equipment, follow the installation steps described earlier. The supply plug of the adapter must be the last connection made. You should NOT connect the cables for serial configuration, phone or PBX while the MobiLink ISDN 2 GSM unit is powered. Also, don't take out the antennas while MobiLink is working.

### 3.10. Significance of LED indicators

The MobiLink ISDN 2 GSM equipment has three LED as optical status indicators, shown in the figure to the right.

Location of the LED status indicators: from top downwards you have the GSM LED, the ISDN LED and the power supply LED.

The first two are bi-color (red / green) while the Power led lights only green.

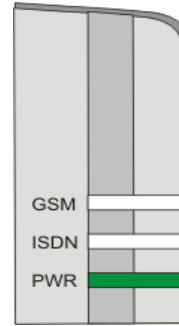

**Figure 3-8 Location of the LED status indicators**

#### Functions of LED's status

Each LED may light green or red, continuously or blinking with different frequencies, as shown in the table below:

LED	Status	Significance
Topmost (GSM)	This dual color LED shows the status of GSM modules. It lights green to indicate GSM 0 and red to indicate GSM 1.	
	Blinking fast, 5 Hz	The GSM module is initializing
	Blinking, 1 Hz	Wrong PIN number (PIN error)
	Blinking slow, 0.5 Hz	GSM module is searching for the network (antenna not installed, or MobiLink not in the coverage area of the GSM network )
	Off	GSM module has registered to the network and is in standby
	On, continuously	GSM module is busy (in a call or just allocated)
Middle (ISDN)	Information about synchronization of ISDN interfaces. Here green color indicates the NT interface and red color refers to the TE interface of MobiLink.	

	Blinking 0.25 sec then one sec off	Interface not synchronized. For example, if green LED lights 0,25 sec then red LED lights 0,25 sec it means both interfaces are not synchronized.
	Off	The ISDN interface is synchronized
Lower (Power)	Lights continuously green	The supply voltage is present
	Off	There is no supply voltage

### 3.11. Pinout for the connectors

MobiLink ISDN 2 GSM features four data connectors at the bottom of its case. All connectors are of the same type, female RJ-45, but they have different functions. Please read the paragraph carefully and perform the connections accordingly.

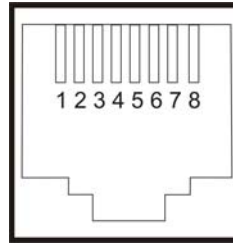

#### Serial connector

For programming MobiLink ISDN 2 GSM you must use the special connection cable. The special serial cable is included in the package of the MobiLink ISDN 2 GSM equipment.

The end towards MobiLink features a RJ11 connector while the end towards the COM port of the computer features a standard female DB-9 connector.

In the drawing below you see the pin numbering (from left to right) of the RJ11 female connector of MobiLink and the corresponding male RJ11 connector on the serial programming cable.

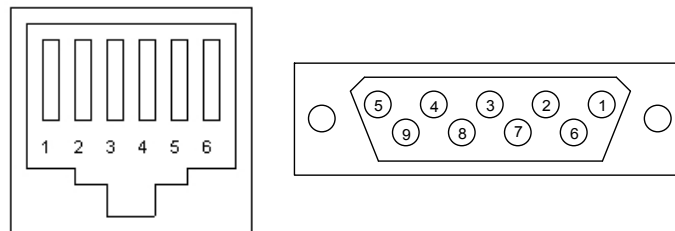

**Figure 3-9 Serial connector**



See table below for pinout of cable and its connectors.

<b>RJ11</b>	<b>Symbol</b>	<b>DB-9</b>	<b>Signal</b>
1	DSR	6	Data Set Ready, input
2	RxD	3	Receive Data, input
3	GND	5	Signal Ground
4	TxD	2	Transmit Data, output
5	DTR	4	Data Terminal Ready, input
6	CTS	8	Clear To Send, input

**TE connector** – used for connecting the MobiLink TE interface.

The TE interface of the MobiLink ISDN 2 GSM unit is used for connection to NT interfaces of the ISDN private branch exchange or of the ISDN public telephony network. TE interfaces are provided with embedded termination resistors. These resistors may be enabled by means of corresponding jumpers, the pair JAT1 and JAT2.

See table below for pinout of TE interface

Pin	Signal
1	not connected
2	not connected
3	Tx
4	Rx
5	Rx
6	Tx
7	not connected
8	not connected

**NT connector** – used for connecting the MobiLink NT interface.

The NT ISDN interface of MobiLink is to be used for connection to TE interfaces of the ISDN PBX or to ISDN terminals.

For pinout of NT interface of MobiLink see table below:

Pin	Signal
1	not connected
2	not connected
3	Rx
4	Tx
5	Tx
6	Rx
7	not connected
8	not connected

**SY connector**

The Synchronization connector is internally paralleled to the TE interface of MobiLink.

This is used when connecting several MobiLink ISDN 2 GSM units together, to ensure synchronous operation of all devices.

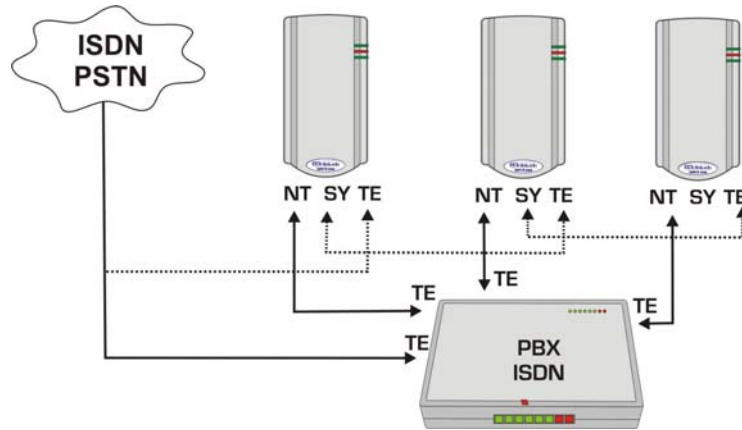

**Figure 3-10 Usage of SY connector**

For details see Chapter 4.2, about modes of connecting the MobiLink ISDN 2 GSM unit.

### 3.12. Mounting the MobiLink ISDN 2 GSM equipment

When selecting the location for mounting MobiLink please bear in mind the recommendations from the paragraph "Operating environment"

The Topex ISDN 2 GSM equipment can be placed either in vertical position on a wall or horizontally on a desk or in a shelf.

MobiLink ISDN 2 GSM and its antennas must be located as far as possible from equipment that is sensitive to electromagnetic interferences (radios, audio or video appliances, computer monitor, TV receivers etc). Also, the GSM antennas must be mounted in a place with maximum strength of the received signal.

For mounting MobiLink ISDN 2 GSM on a wall you must use the mounting kit (plastic dowels, woodscrews, etc) provided by Topex.

Perform the following steps:

- mark the position of a pair of holes on the wall, spaced at 55 mm apart
- drill the holes in the wall
- forcibly insert into the holes the plastic dowels
- thread the metallic woodscrews into the plastic dowels leaving the end to protrude outside for some 5 mm
- hang the case of MobiLink ISDN 2 GSM in the two metallic woodscrews and push it down a little to get it fixed

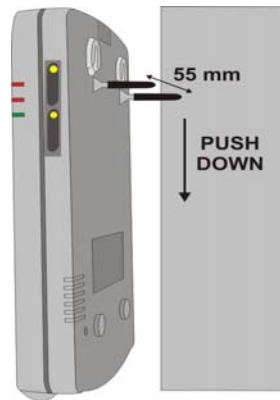

**Figure 3-11 Mounting MobiLink on a wall**

## 4. Installing the OAM program

The OAM program called ISDNCFG is required in order to configure and control the MobiLink ISDN 2 GSM equipment. Also, it allows you to send and receive SMS messages from the computer that is connected to MobiLink via serial cable.

This Operation, Administration, and Maintenance program runs under Windows operating system.

To install the program, connect to the MobiLink the PC you will use for programming, by means of the special serial cable for configuration.

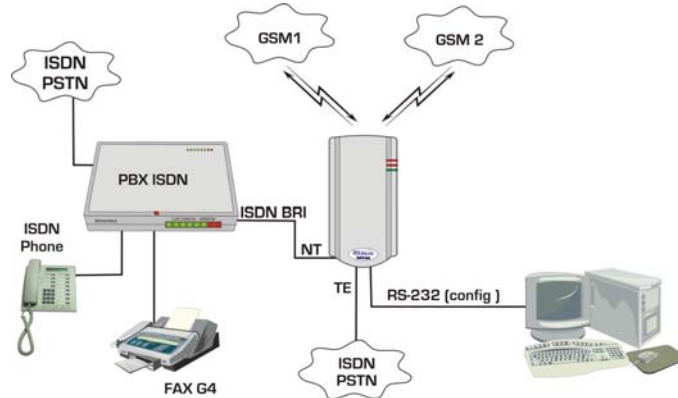

**Figure 4-1 Configuring MobiLink via serial connection**

Set the communication on the COM serial channel where the MobiLink ISDN 2 GSM is connected.

Just insert the diskette into the 3,5 inch diskette drive unit and copy the structure of folders and files to your hard disk drive.

Then run the ISDNCFG.EXE file from the folder on the hard disk

By means of the graphic interface of the configuration program you can begin to adjust MobiLink settings (parameters for GSM modules, ISDN TE and NT interfaces, routing table, CLIP table, name of connection, etc.)

You must establish the settings according to the routing functions that your application requires.

For details, please see the “**Operating Manual**” for the OAM program ISDNCFG. The manual includes several examples of configuration of parameters for usual applications.

Also, the OAM program features online help, providing you information about each command.

## 5. Operation and modes of connection

### 5.1. Routing for least costs

No matter which mode of connection is used, the purpose of MobiLink is to achieve Least Cost Routing of calls. The LCR function of the MobiLink ISDN 2 GSM interface ensures that in each case calls (incoming or outgoing) are routed through the direction with minimum costs. For example, if a local subscriber of the PBX makes a call, the prefix will be analyzed and the call will be routed accordingly, either to the public ISDN network or to one of the GSM operators. This way, instead of paying for a fixed-to-mobile call, you will have only the low cost of a fixed-to-fixed or mobile-to-mobile call inside the same network. This holds true also for calls coming in from your agents in the field who make calls from mobile phone: they will pay just for a mobile-to-mobile conversation, avoiding interconnection fees. Using the DISA feature, the mobile callers may get the extension they want, without need for a human operator of the PBX.

Alternately, the two GSM channels of MobiLink may feature SIM cards for the same mobile provider, but with different subscriptions. The OAM program will select the best subscription for any given moment of time (for example, the operator that provides lower tariff by night or during the weekend).

Another instance of getting lower tariff by using MobiLink is when several subscribers of your PBX make calls to a certain mobile provider. Since most of the calls to that provider will be routed through a specific GSM module of MobiLink, you may use for that module a SIM with convenient tariff rate (low cost per minute for a very large number of minutes used).

In case you connect several MobiLink ISDN 2 GSM units to an ISDN phone exchange, the possibilities of routing calls for least costs are even better. First, you are no longer limited to two GSM modules, you may use modules with SIM cards for two or three mobile providers, each with different subscription that allows you to get a better tariff rate.

Second, if all GSM modules in a MobiLink interface are engaged (busy), the call to a mobile network may not only be rejected but instead routed through another MobiLink ISDN 2 GSM connected to the same PABX.

The OAM program uses CLIP to check the identity of the callers against a data base. Thus calling can be restricted to certain selected (authorized) subscribers, avoiding unnecessary costs.

Caller identification may be used for automated routing of calls.

All incoming call that contains information about the phone number of the subscriber (ID) will be checked by the OAM program against the CLIP routing list. Depending upon the "Action" you have set up,

the program will route the call accordingly, to the operator of the PBX, to a certain local extension or will provide DISA tone.

DISA – direct inward access – allows callers to select the extension they want without help from an operator, via DTMF codes. Also, they can dial out of the exchange.

If the incoming ID is missing, the default routing options apply.

With the “Nr. of Dialed Digits” option MobiLink makes the call immediately after receiving the last digit, any digit sent afterwards will be ignored.

## 5.2. Modes of connection

Here you have a few examples of connecting the MobiLink equipment to an ISDN phone exchange.

The ISDN 2 GSM interface can be connected either as TE, when it acts as a terminal equipment, or as NT, when it simulates ISDN network.

Also, it may be used as a pass-through device that is “transparent” for the calls. In this case the MobiLink ISDN 2 GSM equipment is inserted between the public ISDN network and the PBX.

These three basic modes of connecting MobiLink can be combined in different ways, as shown further.

### 5.2.1 MobiLink connected via NT to a TE junction of the PABX

NT connector of the GSM-2-ISDN linked to TE of the PABX, TE of the PABX goes to the public ISDN. You may use the TE interface to get the clock signal for synchronization, as shown below.

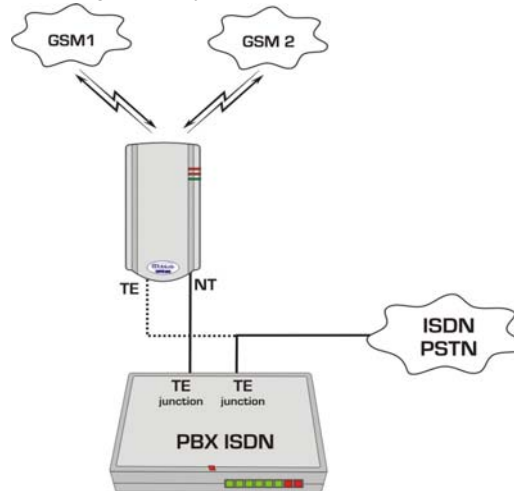

Figure 5-1 MobiLink connected to TE junction of PBX

### Outgoing from PABX

The PBX routes the calls to mobile networks through the MobiLink unit. The MobiLink may use one or two directions for this (DIR0 for module GSM0, one mobile network, DIR1 for module GSM1, the other mobile operator)

### Incoming GSM to PABX

The decision is taken depending upon the CLIP GSM table or the GSM port settings if the incoming phone number is not found in the table.

The call is sent only thru the MobiLink's TE interface. In the CLIP-GSM table, the "ACTION" field value must be set on "NT" and the "Port" field from "GSM settings" menu will be set on "NT".

### 5.2.2 MobiLink connected via TE to NT local of PABX and via NT to TE junction of the PABX

NT connector of the GSM-2-ISDN linked to one TE junction of the PABX. Other TE junction of the PABX goes to the public ISDN network. The TE connector of the GSM-2-ISDN unit goes to the NT of a local board of the PABX

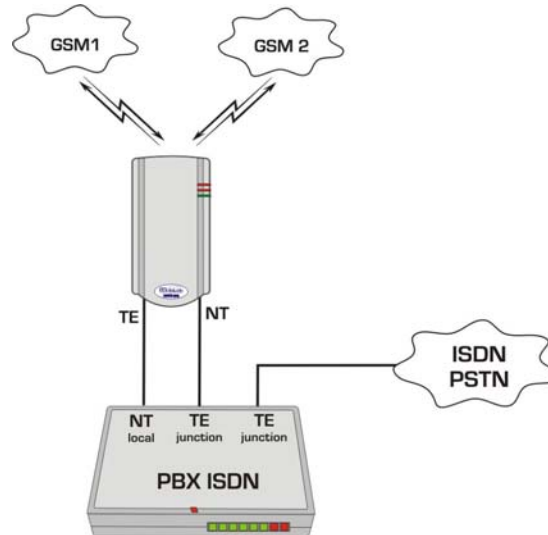

Figure 5-2 MobiLink connected to PBX with both NT and TE interfaces



### Outgoing from PABX

The PABX unit verifies the number dialed and routes the call for the public network thru the dedicated interface and the call for the mobile network thru the MobiLink's NT interface. The MobiLink unit selects one mobile network operator to send the call.

### Incoming to PABX

Calls get into PABX via TE connector. When an incoming GSM call comes in, if the setting in the GSM window is Operator, the call will go to the local extension from Target. From the PABX the call is considered to be a local call!

If the setting is DISA, the caller gets a DISA tone and he can dial any local subscriber he wishes. Also, he can make calls from the public network, acting as a local subscriber.

### 5.2.3 MobiLink connected to PBX on NT interface and to public ISDN via TE interface

The public ISDN network is connected directly to the Topex MobiLink equipment via TE interface. The NT connector is used to link to a TE junction of the PABX.

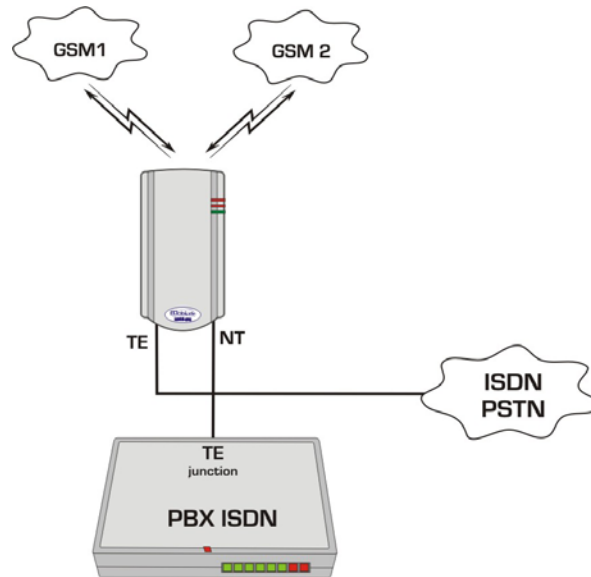

Figure 5-3 MobiLink inserted between PBX and public network

### Outgoing calls

In this case calls coming from PABX junction through NT connector of ISDN-2- GSM can be routed through one of the three directions: GSM0, GSM1 and TE (which goes to the public ISDN network). The routing is performed by the MobiLink ISDN-2- GSM unit.

### Incoming to PABX from ISDN network

The calls from the public ISDN are transferred transparently towards the PABX. For this, in the TE configuration window check "PassThrough" options.

### Incoming to PABX from GSM network

The calls from GSM network are treated according to the specifications presented on paragraph "a".

## 5.2.4 MobiLink connected to PABX via TE only

The TE interface of the MobiLink is connected to the NT of a local board of the PABX.

The NT interface of ISDN-2- GSM is **not used** in this case.

The PABX connects to the public ISDN via another TE junction.

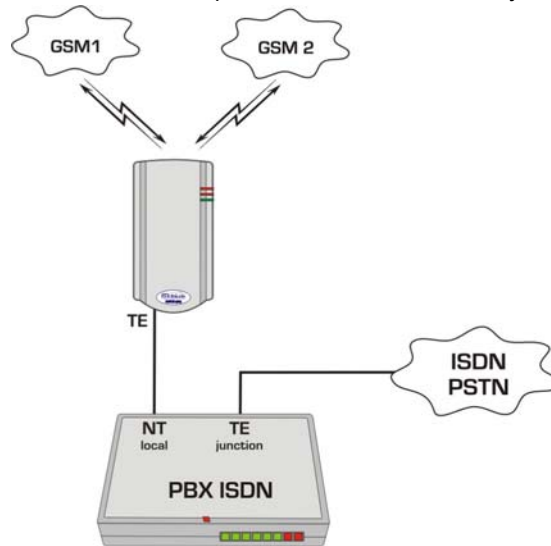

Figure 5-4 MobiLink connected to NT local of PBX

### Outgoing from PABX

The local subscriber calls the number of the local extension on position where the MobiLink is connected. MobiLink answers, takes over the numbering, then sends out the call into the adequate GSM network. The number of the mobile subscriber must be dialed in DTMF mode.

### Incoming to PABX from the GSM network

As shown earlier, the call identity is checked with the CLIP-GSM table and the call is sent thru the MobiLink's TE interface to the PABX. If the call identity is missing or it can't be found in the CLIP-GSM table, the call will be routed according to the settings of the GSM module ("DISA" or "OPERATOR").

#### 5.2.5 Using several MobiLink ISDN 2 GSM units

There are situations when you need to connect more than one MobiLink unit to a PABX: when you must use more than two mobile network directions or there is a lot of traffic towards the mobile network.

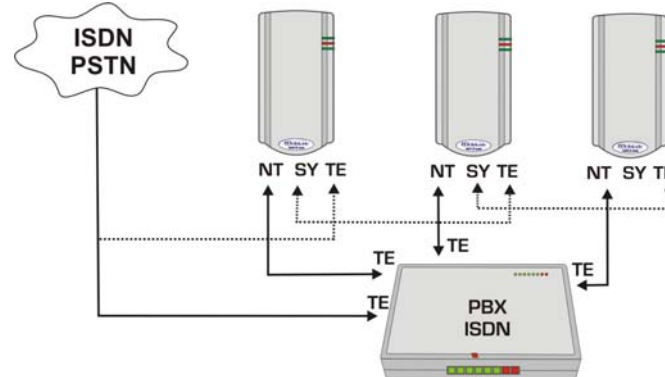

Figure 5-5 Cascading several MobiLink units

To ensure synchronous operation of the MobiLink units, clock synchronization is taken from the Public ISDN and goes to the TE connector of the first MobiLink.

Please check the figure above to see the connection mode.

REMEMBER! When you use more than one ISDN terminals on the same ISDN line (4 wire bus), you must end the ISDN line with terminal resistors.

For this, you can use a termination line jack (termination block) with adequate impedance matching resistors (value is 100 ohm). Alternately, if the last device is a MobiLink ISDN equipment, you may use the embedded termination resistors. Both NT and TE interfaces of the MobiLink ISDN equipment feature termination resistors which can be configured by means of jumpers.

The pair of jumpers JAN1 and JAN2 connects the matching resistors to the NT interface, while the pair of jumpers JAT1 and JAT2 connects the matching resistors to the TE interface of MobiLink.

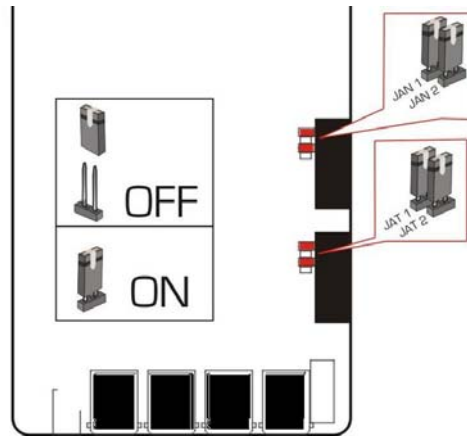

**Figure 5-6 Location of JAT1, JAT2, JAN1 and JAN2 jumpers**

By default, all jumpers are set, so termination resistors are connected.



**Note:**

Remember to take the jumpers OFF as required. In a configuration with several ISDN terminals connected together, only the last device in the line must have termination resistors

## 6. Technical specifications

<b>GSM modules</b>	
Mobile networks	Dual-Band EGSM900 and GSM1800
Compliant to	GSM phase 2/2+
Maximum RF output power	Class 4 (2 W) for EGSM900 Class 1 (1 W) for GSM1800
Control	via AT commands
Power consumption:	<ul style="list-style-type: none"> <li>- Idle mode (registered) 25 mA</li> <li>- Speech mode 300 mA</li> <li>- Peak &lt;2.5 A</li> <li>- Power down 50 mA</li> <li>- Sleep mode 3.5 mA</li> </ul>
Reception sensitivity	-104 dBm
SIM card	3 V, plug-in card
Antenna connector	FSM, 50 $\Omega$ impedance
External antenna	Dual band, 3m long cable, magnetic base
Extra features	<ul style="list-style-type: none"> <li>- DTMF (Dual Tone Multi Frequency)</li> <li>- Half rate, Full rate or Enhanced full rate</li> <li>- Echo cancellation and Noise reduction</li> </ul>
Optical indicator	Dual color LED, green for GSM 0 and red for GSM 1

<b>Line (ISDN)</b>	
Connectors	Standard RJ45 connector for ISDN
ISDN protocol	EuroISDN, DSS - 1
NT interface	So, point to multipoint So, point to point
TE interface	So, point to multipoint So, point to point
SY	Synchronization, paralleled to TE
Optical indicator	Dual color LED, red for TE interface and green for NT interface

<b>Power supply</b>	
Special adapter	Input: Mains 230 V AC 0,3A / 50Hz Output: jack, 12V DC / 2,08A

<b>Serial interface</b>	
Standard	RS-232
Connector	Dedicated RJ-45
Signals	RTS, DSR, RxD, TxD, DTR, CTS, GND.

<b>Overall</b>	
Operating temperature range	From 5 to 50°C
Humidity	10 to 80%, non-condensing
Dimensions (L x W x H)	222 x 115 x 32 mm
Weight	500 g – MobiLink ISDN 2 GSM unit 1 kg – the whole package

## 7. Operating environment

MobiLink ISDN 2 GSM equipment was designed to work **inside** buildings, so it must be installed only in closed rooms or enclosures, where the environment conditions should be inside the limits specified in the "Tech specs" table.

You must NOT allow exposure to rain, dripping water, condensed humidity, mist, etc

You should avoid dust and prolonged exposure to Sun radiation.

In order to ensure adequate working temperature, the ISDN 2 GSM interface must not be used too near heat sources or in direct sunshine.

Also, it must not be overcrowded: you must leave free space around, below and above the MobiLink interface. This is needed both for connecting phone / data / antenna cables, and also for ventilation (natural air cooling to dissipate the heat generated during operation).

Remember, when allowed operating temperature is exceeded this may not have an immediate, visible effect on the MobiLink unit, but it can result in unreliable operation, accelerated ageing and hence diminishing of lifetime.

MobiLink ISDN 2 GSM must NOT be used in flammable or explosive environment, or in locations where toxic, aggressive, corrosive or flammable gases may accumulate.

When cleaning the plastic case of the unit, take care not to use aggressive liquids or solvents.

The MobiLink equipment should be handled with care, to avoid mechanical shocks and blows.

It must not be used in places with high level of vibrations such as manufacturing floors, heavy-duty trailers or railway cars.

Also, MobiLink ISDN 2 GSM should not be used in an environment with high level of EMI (electromagnetic interference), near copiers, PC monitors, TV sets or other audio-video appliances or high power equipment such as electric motors or heaters.

When selecting the location for installing MobiLink ISDN 2 GSM and its external antennas you must remember the recommendations described in the chapter about mounting the equipment.

MobiLink ISDN 2 GSM does not include materials or components that are harmful to the environment.

When the life cycle of this equipment is finished and it cannot be repaired or re-used anymore, you should dispose of it in accordance with laws and legal regulations that are valid in your area.

## 8. Benefits

MobiLink ISDN 2 GSM creates a direct voice connection between an digital fixed telephone and the GSM wireless communications network. You connect the cable of the ISDN phone exchange or ISDN terminal to the MobiLink ISDN 2 GSM unit and have access to the mobile network without the need for a connection (landline) to the fixed telephony operator.

Also, if you want to call from a mobile terminal, you will dial the number of the SIM inserted into the slot of the MobiLink ISDN 2 GSM unit and your call will be automatically directed to the fixed phone in your office home.

The main advantage of using the ISDN 2 GSM is eliminating interconnection costs between fixed and mobile telephony networks. Thus, MobiLink is generally connected to an ISDN PBX that provides routing and distributes the calls to all local subscribers. But it can also be useful for private persons or small companies who don't have access to the fixed telephony network, that is they have no phone landline to their homes or offices. With MobiLink ISDN 2 GSM GSM they will be able to use their ISDN fixed phone to call anywhere through the GSM telephony network.

### THE BENEFITS INCLUDE:

- The immediate installation of an ISDN connection in remote areas, that may not be reached by phone lines, but which are inside the coverage area of the GSM mobile network
- The means of easy use of an ISDN terminal (telephone sets), for calls to a GSM network.
- Getting rid of the radiation of the cellphone. The GSM modems and the external antennas of MobiLink ISDN 2 GSM will NOT be located near the user or close to Hi-Fi audio or video appliances that could be sensitive to EMI.
- Sending and receiving SMS from the computer that is connected to MobiLink, by means of its convenient e-mail to SMS and SMS to e-mail features.



The manufacturer reserves the right to modify the product and manual for the purpose of technical improvement without prior notice. The manufacturer guarantees the good functioning of the product provided that it has been correctly installed and the directives for storage and usage have been respected. The warranty implies exclusively repairing or replacing the defective unit. The warranty does not include any indirect losses or loss of profit. The manufacturer is not liable for any damage, whether direct, indirect, special, incidental, or consequential, as a result of using **MobiLink ISDN 2 GSM**.

No part of this manual may be reproduced, stored in a retrieval system, or transmitted, in any form or by any means, electronic, mechanical, recording, or otherwise, without the prior written permission of the company TOPEX S.A.

We certify hereby that the **MobiLink ISDN 2 GSM** unit is manufactured in concordance with the legal provisions concerning responsibility towards the quality of delivered products, fulfills the quality parameters specified in its "User's manual" and is fit for the purpose for which it has been designed. We also warrant that the equipment will perform substantially in accordance with the accompanying documentation.

Any comments, suggestions and proposals of yours concerning our products are welcome and we are gladly waiting for your feedback at the following address.

**TOPEX S.A.**  
**Feleacu nr. 10, sector 1**  
**Bucharest 014186, ROMANIA**

**Tel: +4021 408 39 00**  
**Fax: +4021 408 39 09**

**E-mail: [topex @ topex.ro](mailto:topex@topex.ro)**  
**Web: [www.topex.ro](http://www.topex.ro)**